

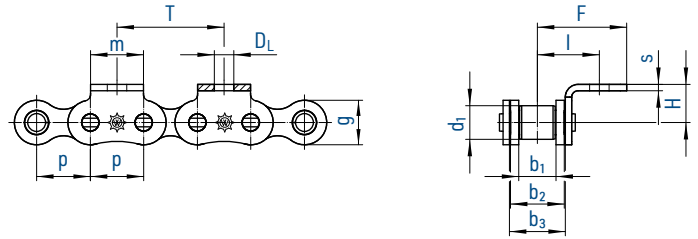

Type A bent attachments, one side

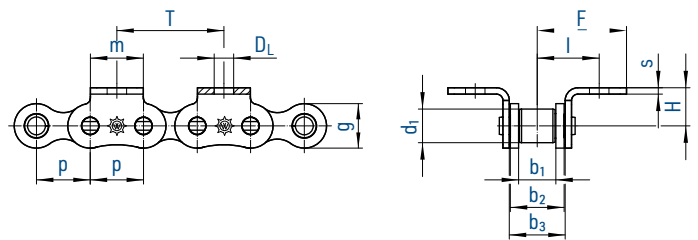

Type B bent attachments, both sides



Type C bent over chain attachments, one side

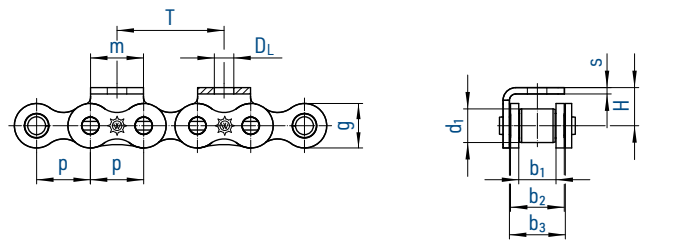

Basic chain		Pitch		Inner width	Inner link width	Outer plate width	Roller Ø	Plate height	Attachment dimensions					
No.	Ind.	p		b ₁ min.	b ₂ max.	b ₃ min.	d ₁ max.	g max.	m	D _L	l	F	H	s
		mm	inch	mm	mm	mm	mm	mm	mm	mm	mm	mm	mm	mm
450		8,000	-	3,00	4,77	4,90	5,00	7,1	8,0	3,2	6,6	12,0	5,0	0,80
455	^{1,15}	9,525	3/8	5,72	8,53	8,66	6,35	8,2	8,0	3,5	9,5	13,5	6,5	1,25
331	¹⁷	12,700	1/2	3,30	5,80	5,93	7,75	9,9	10,5	3,5	9,0	15,1	7,0	0,95
332	¹⁷	12,700	1/2	4,88	7,20	7,33	7,75	9,9	10,5	3,5	9,7	15,8	7,0	0,95
462	¹⁵	12,700	1/2	7,75	11,30	11,43	8,51	11,8	12,5	4,5	13,1	19,0	10,0	1,50
501	¹⁵	15,875	5/8	9,65	13,28	13,41	10,16	14,7	15,0	5,5	16,7	26,5	10,0	1,70
513	¹⁵	19,050	3/4	11,68	15,62	15,75	12,07	16,1	18,5	6,6	18,6	29,0	11,0	1,80
548	^{15,16}	25,400	1	17,02	25,40	25,60	15,88	21,0	25,0	9,0	28,9	41,8	18,0	3,00
563		31,750	1 1/4	19,56	29,00	29,20	19,05	26,4	35,0	9,0	33,4	49,0	18,0	3,75
596		38,100	1 1/2	25,40	37,90	38,20	25,40	33,4	38,0	11,0	43,6	62,6	25,0	5,00
613		44,450	1 3/4	30,99	46,50	46,80	27,94	37,0	45,0	14,0	54,1	78,0	32,0	6,00
652		50,800	2	30,99	45,50	45,80	29,21	42,2	50,0	14,0	53,6	75,4	35,0	6,00
40	¹⁵	12,700	1/2	7,85	11,17	11,23	7,92	12,0	10,5	3,5	12,7	17,9	7,9	1,50
50	¹⁵	15,875	5/8	9,40	13,84	13,90	10,16	15,1	12,7	5,2	15,9	23,9	10,3	2,00
60	¹⁵	19,050	3/4	12,57	17,75	17,81	11,91	18,1	15,9	5,2	19,1	28,2	11,9	2,40
80	¹⁵	25,400	1	15,75	22,60	22,66	15,88	24,1	19,1	6,7	25,4	37,3	15,9	3,20

¹ with straight side plates ¹⁵ also with single hole bent attachments on inner link ¹⁶ on inner link s = 4 ¹⁷ can also be supplied with m = 16

All designs can also be supplied as MARATHON roller chains (maintenance-free), BIATHLON, BIATHLON KS, TRIATHLON and TRIATHLON KS!
For details on orders and enquiries see page 149. For untoleranced dimensions DIN ISO 2768 c applies.



Type D straight attachments, one side

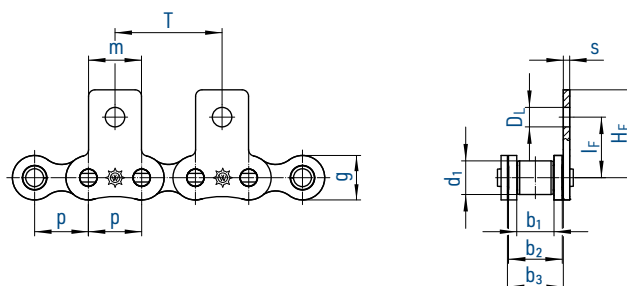

Type E straight attachments, both sides

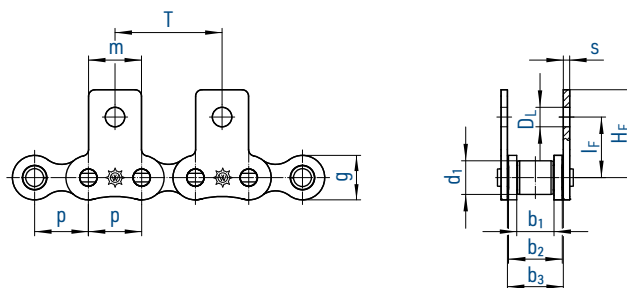

Type F extended pins (available on alternate sides)

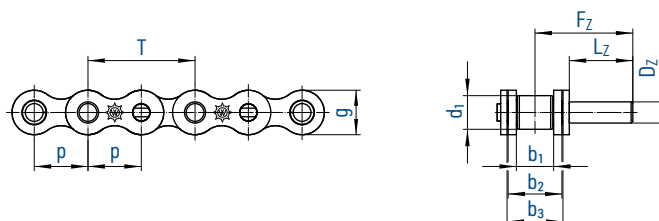

Basic chain		Pitch		Inner width	Inner link width	Outer plate width	Roller Ø	Plate height	Attachment dimensions							
⚙		p		b ₁ min.	b ₂ max.	b ₃ min.	d ₁ max.	g max.	m	D _L	I _F	H _F	s	D _Z ¹⁹ h9	L _Z ¹⁹	F _Z ¹⁹
No.	Ind.	mm	inch	mm	mm	mm	mm	mm	mm	mm	mm	mm	mm	mm	mm	mm
450		8,000	-	3,00	4,77	4,90	5,00	7,1	8,0	3,2	7,5	13,00	0,80	4,0	10,0	13,3
455	^{1,18}	9,525	3/8	5,72	8,53	8,66	6,35	8,2	8,0	3,5	9,3	13,30	1,25	5,0	15,0	20,7
331	¹⁷	12,700	1/2	3,30	5,80	5,93	7,75	9,9	10,5	3,5	11,3	17,55	0,95	5,0	15,0	19,0
332	¹⁷	12,700	1/2	4,88	7,20	7,33	7,75	9,9	10,5	3,5	11,3	17,55	0,95	5,0	15,0	19,7
462	¹⁸	12,700	1/2	7,75	11,30	11,43	8,51	11,8	12,5	4,5	14,7	20,30	1,50	6,0	15,0	22,4
501	¹⁸	15,875	5/8	9,65	13,28	13,41	10,16	14,7	15,0	5,5	17,2	26,70	1,70	6,5	20,0	28,5
513	¹⁸	19,050	3/4	11,68	15,62	15,75	12,07	16,1	18,5	6,6	18,3	28,60	1,80	7,0	20,0	29,8
548	^{16,18}	25,400	1	17,02	25,40	25,60	15,88	21,0	25,0	9,0	28,6	41,50	3,00	10,0	30,0	45,9
563		31,750	1 1/4	19,56	29,00	29,20	19,05	26,4	35,0	9,0	30,5	46,00	3,75	12,0	30,0	48,4
596		38,100	1 1/2	25,40	37,90	38,20	25,40	33,4	38,0	11,0	41,0	60,00	5,00	16,0	35,0	59,1
613		44,450	1 3/4	30,99	46,50	46,80	27,94	37,0	45,0	14,0	52,5	75,50	6,00	20,0	40,0	69,0
652		50,800	2	30,99	45,50	45,80	29,21	42,2	50,0	14,0	53,5	76,10	6,00	20,0	40,0	69,0
40		12,700	1/2	7,85	11,17	11,23	7,92	12,0	10,5	3,5	11,5	17,65	1,50	5,0	15,0	22,2
50		15,875	5/8	9,40	13,84	13,90	10,16	15,1	12,7	5,2	15,9	23,50	2,00	5,08	11,9	21,1
60		19,050	3/4	12,57	17,75	17,81	11,91	18,1	15,9	5,2	18,3	27,20	2,40	5,94	14,3	25,8
80		25,400	1	15,75	22,60	22,66	15,88	24,1	19,1	6,7	24,6	35,50	3,20	7,92	19,1	33,7

¹ with straight side plates ¹⁶ on inner link s = 4 ¹⁷ can also be supplied with m = 16 ¹⁸ also with straight attachments on inner link

¹⁹ other dimensions available on request

All designs can also be supplied as MARATHON roller chains (maintenance-free), BIATHLON, BIATHLON KS, TRIATHLON and TRIATHLON KS!
For details on orders and enquiries see page 149. For untoleranced dimensions, DIN ISO 2768 c applies.



Type A2 bent attachments, one side

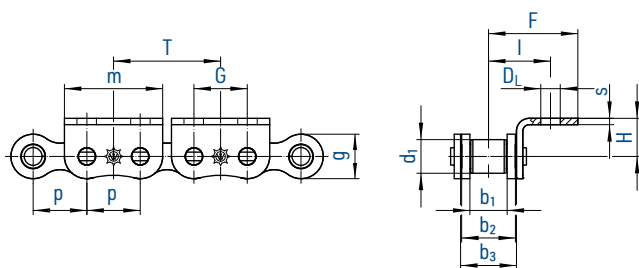

Type B2 bent attachments, both sides

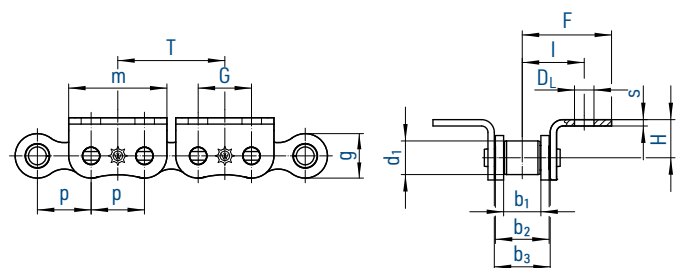

Type D2 straight attachments, one side

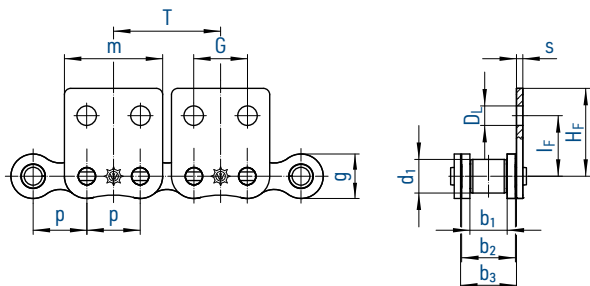

Type E2 straight attachments, both sides

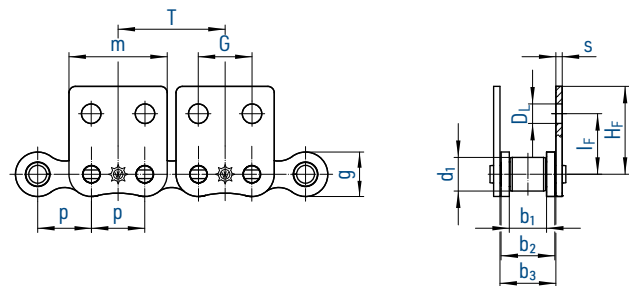

Basic chain		Pitch		Inner width	Inner link width	Outer plate width	Roller Ø	Plate height	Attachment dimensions								
⚙		p		b ₁ min.	b ₂ max.	b ₃ min.	d ₁ max.	g max.	m	D _L	G	I	F	H	l _F	H _F	s
No.	Ind.	mm	inch	mm	mm	mm	mm	mm	mm	mm	mm	mm	mm	mm	mm	mm	mm
455	^{1,20}	9,525	3/8	5,72	8,53	8,66	6,35	8,2	18,2	3,2	9,5	9,8	13,5	5,7	9,2	12,6	1,25
462		12,700	1/2	7,75	11,30	11,43	8,51	11,8	24,4	4,5	12,7	13,1	19,0	10,0	14,7	20,3	1,50
501		15,875	5/8	9,65	13,28	13,41	10,16	14,7	30,3	5,5	15,9	16,7	26,5	10,0	17,2	26,7	1,70
513		19,050	3/4	11,68	15,62	15,75	12,07	16,1	34,8	6,6	19,1	18,6	29,0	11,0	18,7	28,6	1,80
548		25,400	1	17,02	25,40	25,60	15,88	21,0	46,5	9,0	25,4	28,9	41,8	18,0	28,6	41,5	3,00
563		31,750	1 1/4	19,56	29,00	29,20	19,05	26,4	55,8	9,0	31,8	33,4	49,4	18,0	30,5	46,0	3,75
596		38,100	1 1/2	25,40	37,90	38,10	25,40	33,4	71,1	11,0	38,1	43,6	62,6	25,0	41,0	60,0	5,00

Roller chains (stainless steel) with two-hole bent and straight attachments

455 RF	^{1,20}	9,525	3/8	5,72	8,53	8,66	6,35	8,2	18,2	3,2	9,5	9,8	13,2	5,7	9,2	12,6	1,25
462 RF		12,700	1/2	7,75	11,30	11,43	8,51	11,8	24,4	4,5	12,7	13,1	19,0	10,0	14,7	20,3	1,60
501 RF		15,875	5/8	9,65	13,28	13,41	10,16	14,7	30,3	5,5	15,9	16,7	26,5	10,0	17,2	26,7	1,70
513 RF		19,050	3/4	11,68	15,62	15,75	12,07	16,1	34,8	6,6	19,1	18,5	29,0	11,0	18,7	28,6	1,80
548 RF		25,400	1	17,02	25,40	25,60	15,88	21,0	46,5	10,0	25,4	28,9	41,8	18,0	28,6	41,5	3,00

¹ with straight side plates ²⁰ can be supplied with or without bore

All designs can also be supplied as MARATHON roller chains (maintenance-free), BIATHLON, BIATHLON KS, TRIATHLON and TRIATHLON KS! Sprockets made of stainless steel or plastic are available on request.

For details on orders and enquiries see page 149. For untoleranced dimensions DIN ISO 2768 c applies.



Type A bent attachments, one side

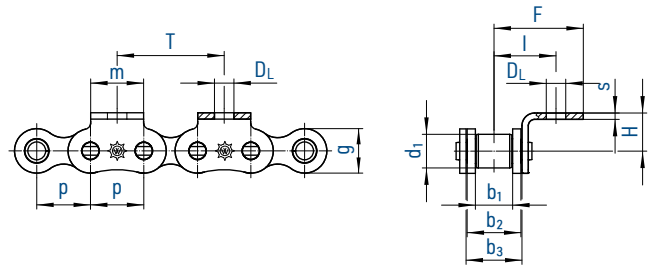

Type B bent attachments, both sides

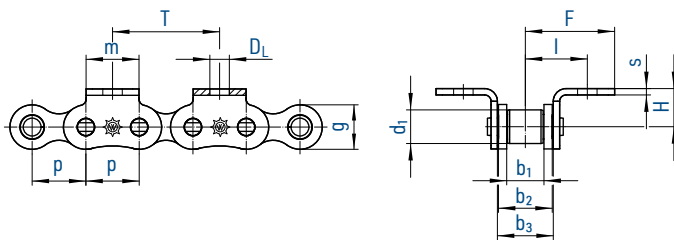

Type D straight attachments, one side

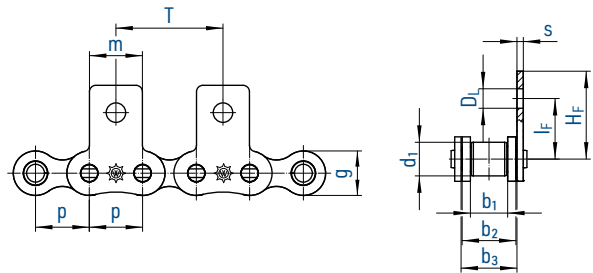

Type E straight attachments, both sides

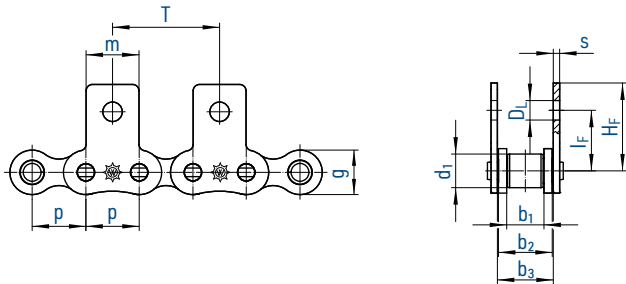

Type F extended pins (available on alternate sides)

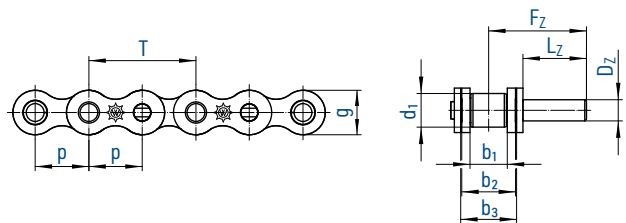

Basic chain		Pitch	Inner width	Inner link width	Outer plate width	Roller Ø	Plate height	Attachment dimensions											
								p	b ₁ min.	b ₂ max.	b ₃ min.	d ₁ max.	g max.	m	D _L	I	F	H	I _F
No.	Ind.	mm	mm	mm	mm	mm	mm	mm	mm	mm	mm	mm	mm	mm	mm	mm	mm	mm	mm
450 RF		8,000	3,00	4,77	4,90	5,00	7,1	8,0	3,2	6,6	12,0	5,0	7,5	13,0	0,80	4,0	10	13,3	
455 RF	^{1,21}	9,525	5,72	8,53	8,66	6,35	8,2	8,0	3,5	9,5	13,5	6,5	9,3	13,3	1,25	5,0	15	20,7	
331 RF	¹⁷	12,700	3,30	5,80	5,93	7,75	9,9	10,5	3,5	9,0	15,1	7,0	11,3	17,6	0,95	5,0	15	19,0	
40 RF	²¹	12,700	7,85	11,15	11,28	7,95	12,0	10,5	3,5	11,8	17,9	7,9	11,5	17,7	1,50	5,0	15	22,2	
332 RF	¹⁷	12,700	4,88	7,20	7,33	7,75	9,9	10,5	3,5	9,7	15,8	7,0	11,5	17,6	0,95	5,0	15	19,7	
462 RF	²¹	12,700	7,75	11,30	11,43	8,51	11,8	12,5	4,5	13,1	19,0	10,0	14,7	20,3	1,60	6,0	15	22,4	
501 RF	²¹	15,875	9,65	13,28	13,41	10,16	14,7	15,0	5,5	16,7	27,0	10,0	17,2	26,7	1,70	6,5	20	28,5	
513 RF	²¹	19,050	11,68	15,62	15,75	12,07	16,1	18,5	6,6	18,5	29,0	11,0	18,3	28,6	1,80	7,0	20	29,8	
548 RF	^{16,21}	25,400	17,02	25,40	25,60	15,88	21,0	25,0	10,0	28,9	41,8	18,0	28,6	41,5	3,00	10,0	30	45,9	

¹ with straight side plates ¹⁶ on inner link s = 4 ¹⁷ can also be supplied with m = 16 ¹⁹ other dimensions available on request
²¹ also with single hole bent attachments on inner link

Sprockets made of stainless steel or plastic are available on request.

For details on orders and enquiries see page 149. For untoleranced dimensions DIN ISO 2768 c applies.



Type A G
bent attachments, one side

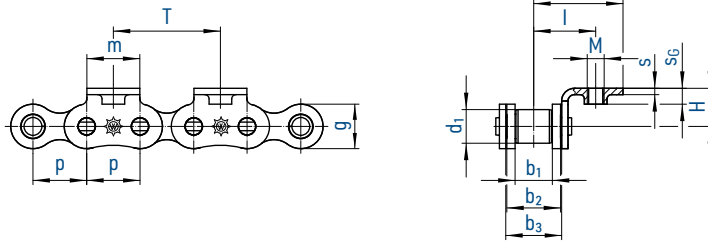

Type B G
bent attachments, both sides

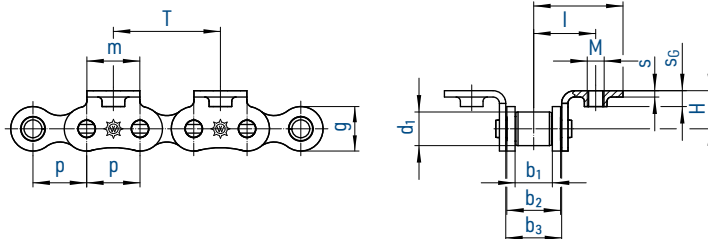

Type C G
bent over chain attachments, one side

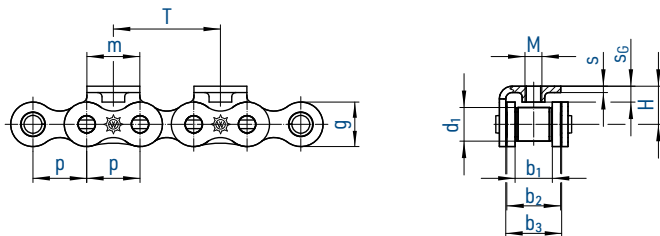

Type D G
straight attachments, one side

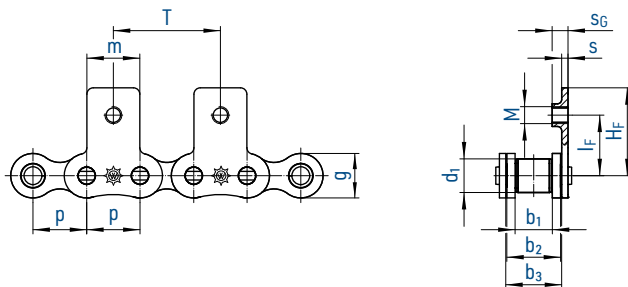

Type E G
straight attachments, both sides

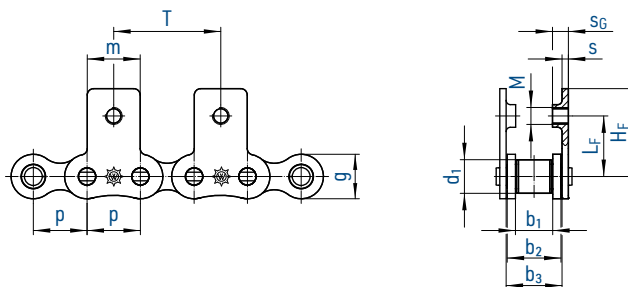

Basic chain		Pitch		Inner width	Inner link width	Outer plate width	Roller Ø	Plate height	Attachment dimensions								
		p		b ₁ min.	b ₂ max.	b ₃ min.	d ₁ max.	g max.	m	M Inside thread	l	F	H	IF	HF	s	S _G
No.	Ind.	mm	inch	mm	mm	mm	mm	mm	mm		mm	mm	mm	mm	mm	mm	mm
462	²²	12,700	1/2	7,75	11,30	11,43	8,51	11,8	12,5	M 4	13,1	19,0	10	14,7	20,3	1,5	4,0
501	²²	15,875	5/8	9,65	13,28	13,41	10,16	14,7	15,0	M 5	16,7	27,0	10	17,2	26,7	1,7	4,2
513	²²	19,050	3/4	11,68	15,62	15,75	12,07	16,1	18,5	M 6	18,5	29,0	11	18,3	28,6	1,8	4,5
548	²²	25,400	1	17,02	25,40	25,60	15,88	21,0	25,0	M 8	28,9	41,8	18	28,6	41,5	3,0	7,5

²² can also be supplied in stainless steel

All designs can also be supplied as MARATHON roller chains (maintenance-free), BIATHLON, BIATHLON KS, TRIATHLON and TRIATHLON KS!
For details on orders and enquiries see page 149. For untoleranced dimensions DIN ISO 2768 c applies.



Type A 2 G
bent attachments, one side

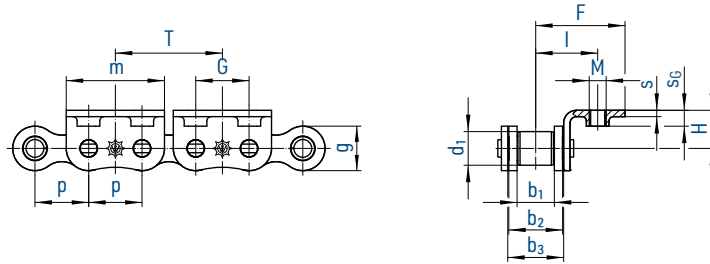

Type B 2 G
bent attachments, both sides

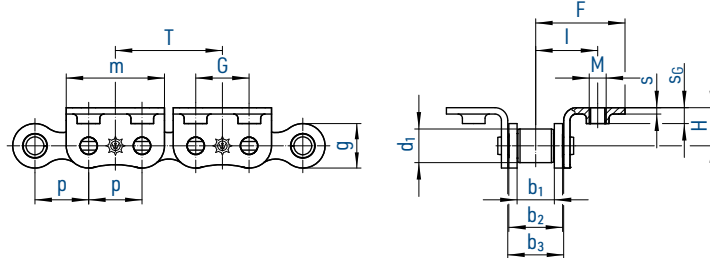

Type C 2 G
bent over chain attachments, one side

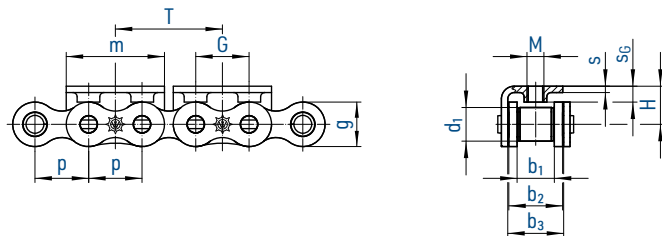

Type D 2 G
straight attachments, one side

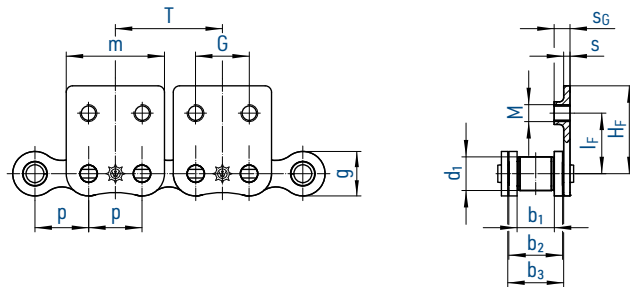

Type E 2 G
straight attachments, both sides

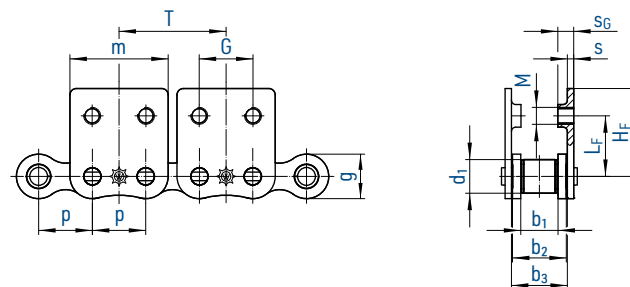

Basic chain		Pitch p	Inner width		Outer plate width b3 min.	Roller Ø d1 max.	Plate height g max.	Attachment dimensions									
Ind.	mm		b1 min.	b2 max.				m	M (Inside thread)	G	I	F	H	LF	HF	s	sG
462	²²	12,700	7,75	11,30	11,43	8,51	11,8	24,4	M 4	12,7	13,1	19,0	10	14,7	20,3	1,5	4,0
501	²²	15,875	9,65	13,28	13,41	10,16	14,7	30,3	M 5	15,9	16,7	27,0	10	17,2	26,7	1,7	4,2
513	²²	19,050	11,68	15,62	15,75	12,07	16,1	34,8	M 6	19,1	18,5	29,0	11	18,3	28,6	1,8	4,5
548	²²	25,400	17,02	25,40	25,60	15,88	21,0	46,5	M 8	25,4	28,9	41,8	18	28,6	41,5	3,0	7,5

²² can also be supplied in stainless steel

All designs can also be supplied as MARATHON roller chains (maintenance-free), BIATHLON, BIATHLON KS, TRIATHLON and TRIATHLON KS!
For details on orders and enquiries see page 149. For untoleranced dimensions DIN ISO 2768 c applies.



Type A
bent attachments, one side

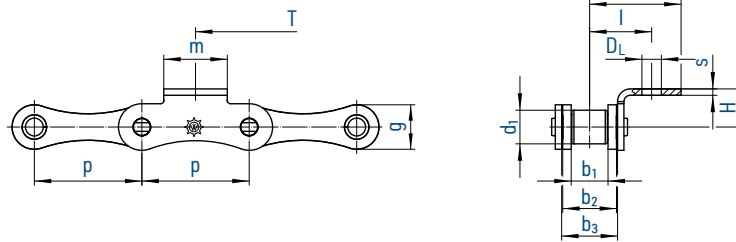

Type B
bent attachments, both sides

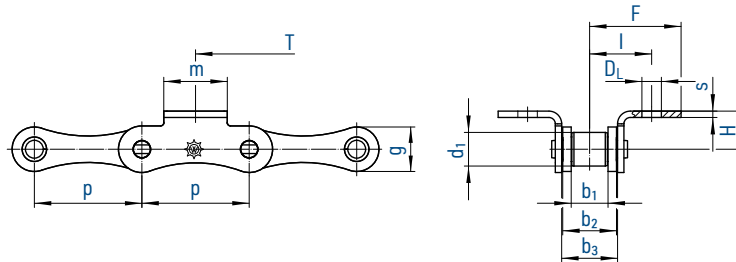

Type C
bent over chain attachments, one side

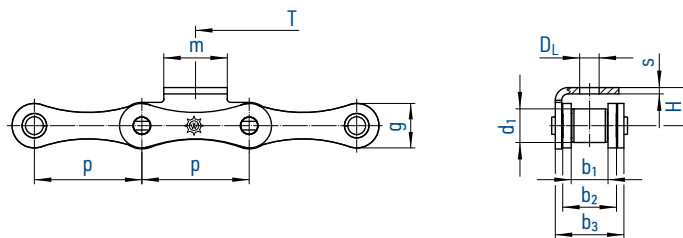

Basic chain		Pitch		Inner width	Inner link width	Outer plate width	Roller Ø	Plate height	Attachment dimensions					
⚙		p		b ₁ min.	b ₂ max.	b ₃ min.	d ₁ max.	g max.	m	D _L	l	F	H	s
No.	Ind.	mm	inch	mm	mm	mm	mm	mm	mm	mm	mm	mm	mm	mm
713		25,40	1	7,75	11,30	11,43	8,51	11,8	13,0	4,5	13,1	19,3	10,0	1,60
717		31,75	1 ¼	9,65	13,28	13,41	10,16	14,7	15,0	5,5	16,7	26,7	10,0	1,70
722		38,10	1 ½	11,68	15,62	15,75	12,07	16,1	19,0	6,6	18,5	26,0	11,0	1,80
728		50,80	2	17,02	25,45	25,58	15,88	21,0	30,0	9,0	28,9	43,0	18,0	3,00
734	*	63,50	2 ½	19,56	29,01	29,14	19,05	28,5	35,0	9,0	33,1	49,6	18,0	3,75

* g-measurement not according to standard

Double pitch stainless steel roller chains with single hole bent attachments

713 RF		25,40	1	7,75	11,30	11,43	8,51	11,8	13,0	4,5	13,1	19,5	10,0	1,60
717 RF		31,75	1 ¼	9,65	13,28	13,41	10,16	14,7	15,0	5,5	16,7	26,7	10,0	1,70
722 RF		38,10	1 ½	11,68	15,62	15,75	12,07	16,1	19,0	6,6	18,5	26,0	11,0	1,80
728 RF		50,80	2	17,02	25,45	25,58	15,88	21,0	30,0	9,0	28,9	43,0	18,0	3,00

All designs can also be supplied as MARATHON roller chains (maintenance-free)!
For details on orders and enquiries see page 149. For untoleranced dimensions DIN ISO 2768 c applies.

Type D
straight attachments, one side

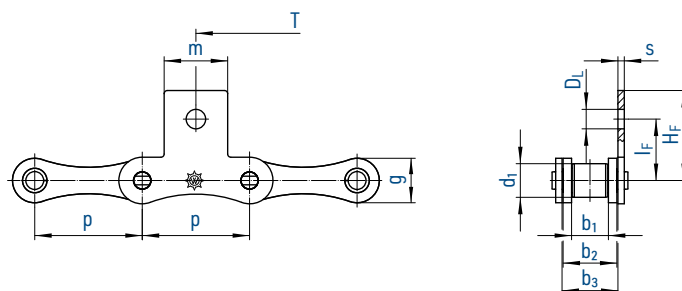

Type E
straight attachments, both sides

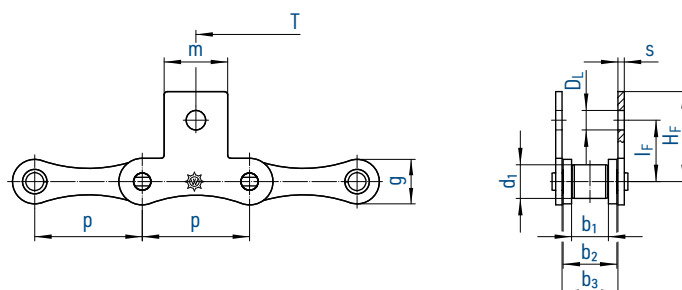

Type F
extended pin
(available on alternate sides)

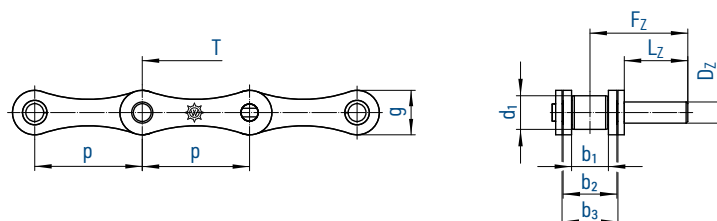

Basic chain		Pitch		Inner width	Inner link width		Outer plate width	Roller Ø	Plate height	Attachment dimensions							
										p	b ₁ min.	b ₂ max.	b ₃ min.	d ₁ max.	g max.	m	D _L
No.	Ind.	mm	inch	mm	mm	mm	mm	mm	mm	mm	mm	mm	mm	mm	mm	mm	mm
713		25,40	1	7,75	11,30	11,43	8,51	11,8	13,0	4,5	14,7	20,3	1,60	6,0	15,0	22,4	
717		31,75	1 ¼	9,65	13,28	13,41	10,16	14,7	15,0	5,5	17,0	26,7	1,70	6,5	20,0	28,5	
722		38,10	1 ½	11,68	15,62	15,75	12,07	16,1	19,0	6,6	17,6	26,0	1,80	7,0	20,0	29,8	
728		50,80	2	17,02	25,45	25,58	15,88	21,0	30,0	9,0	29,0	42,5	3,00	10,0	30,0	45,9	
734	*	63,50	2 ½	19,56	29,01	29,14	19,05	28,5	35,0	9,0	30,5	45,7	3,75	12,0	30,0	48,4	

* g-measurement not according to standard

Double pitch roller chains (stainless steel) with single hole straight attachments and extended pins

713 RF		25,40	1	7,75	11,30	11,43	8,51	11,8	13,0	4,5	14,7	20,3	1,60	6,0	15,0	22,4	
717 RF		31,75	1 ¼	9,65	13,28	13,41	10,16	14,7	15,0	5,5	17,0	26,7	1,70	6,5	20,0	28,5	
722 RF		38,10	1 ½	11,68	15,62	15,75	12,07	16,1	19,0	6,6	17,6	26,0	1,80	7,0	20,0	29,8	
728 RF		50,80	2	17,02	25,45	25,58	15,88	21,0	30,0	9,0	29,0	42,5	3,00	10,0	30,0	45,9	

¹⁹ can also be supplied in stainless steel

Can also be supplied as MARATHON roller chain (maintenance-free)!

For details on orders and enquiries see page 149. For untoleranced dimensions DIN ISO 2768 c applies.

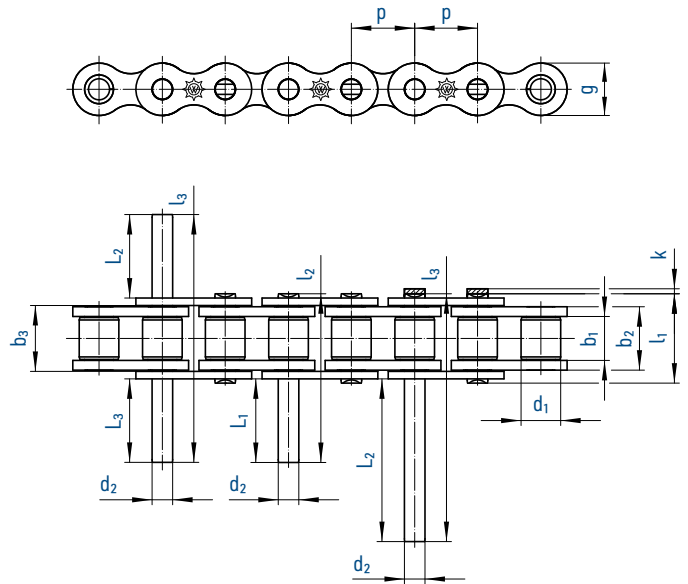

Basic chain		Pitch		Inner width	Inner link width	Outer plate width	Roller Ø	Pin Ø	Projection over connecting link	Plate height	Width over pin	Dimensions for extended pin				
		p		b ₁ min.	b ₂ max.	b ₃ min.	d ₁ max.	d ₂ max.	k max.	g max.	l ₁ max.	Overall length		Pin extension		
No.	Ind.	mm	inch	mm	mm	mm	mm	mm	mm	mm	mm	l ₂ ¹¹ max.	l ₃ ¹² max.	L ₁ max.	L ₂ max.	L ₃ max.
450		8,000	-	3,00	4,77	4,90	5,00	2,31	3,1	7,1	8,6	14,3	19,9	6,3	12,2	6,35
455	^{1,10}	9,525	3/8	5,72	8,53	8,66	6,35	3,28	3,3	8,2	13,5	23,1	33,7	11,0	21,6	11,15
462	¹⁰	12,700	1/2	7,75	11,30	11,43	8,51	4,45	3,9	11,8	17,0	30,7	44,9	15,3	29,5	15,30
501	¹⁰	15,875	5/8	9,65	13,28	13,41	10,16	5,08	4,1	14,7	19,6	36,2	52,8	18,2	34,8	18,00
513	¹⁰	19,050	3/4	11,68	15,62	15,75	12,07	5,72	4,6	16,1	22,7	41,8	61,3	21,0	40,5	20,90
548	¹⁰	25,400	1	17,02	25,40	25,60	15,88	8,28	5,4	21,0	36,0	67,5	99,3	33,6	65,4	33,70
552	¹⁰	30,000	-	17,02	25,40	25,60	15,88	8,28	5,4	21,0	36,0	67,5	99,3	33,6	65,4	33,70
563		31,750	1 1/4	19,56	29,00	29,20	19,05	10,19	6,1	26,4	41,5	79,7	116,1	38,6	75,3	38,70
577		35,000	-	19,60	27,00	27,20	19,05	10,19	6,1	26,0	38,3	79,7	116,1	41,8	78,5	41,80
596		38,100	1 1/2	25,40	37,90	38,10	25,40	14,63	6,6	33,4	53,0	101,8	150,2	50,5	98,7	50,50
613		44,450	1 3/4	30,99	46,60	46,70	27,94	15,90	7,4	37,0	63,6	124,7	184,3	61,7	121,7	62,00
652		50,800	2	30,99	45,60	45,70	29,21	17,81	7,9	42,3	63,6	126,0	184,5	62,2	121,2	62,10
35	¹⁰	9,525	3/8	4,68	7,47	7,52	5,08	3,59	3,3	9,1	13,2	22,0	32,5	11,0	21,5	11,10
40	¹⁰	12,700	1/2	7,85	11,15	11,28	7,95	3,96	3,9	12,0	17,8	30,1	45,2	14,8	29,9	15,35
50	¹⁰	15,875	5/8	9,40	13,80	13,93	10,16	5,08	4,1	15,0	20,5	38,7	56,8	19,4	37,5	19,40
60	¹⁰	19,050	3/4	12,57	17,70	17,85	11,91	5,94	4,6	18,0	25,4	48,3	71,1	24,2	47,0	24,20
80		25,400	1	15,75	22,50	22,70	15,88	7,92	5,4	24,1	33,5	62,6	92,0	31,3	60,6	31,30
100		31,750	1 1/4	18,90	27,40	27,60	19,05	9,53	6,1	30,1	40,4	76,3	112,2	38,2	74,1	38,20
120		38,100	1 1/2	25,22	35,30	35,60	22,23	11,10	6,6	36,2	50,3	96,1	141,9	48,2	94,0	48,20

¹ with straight side plates ¹⁰ can also be supplied in stainless steel ¹¹ Duplex pin ¹² Triplex pin

All designs can also be supplied as MARATHON roller chains (maintenance-free), BIATHLON, BIATHLON KS, TRIATHLON and TRIATHLON KS!
For details on orders and enquiries see page 149. For untoleranced dimensions DIN ISO 2768 c applies.



Simplex chain
with duplex connecting link

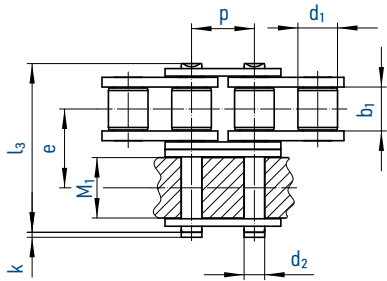

Simplex chain
with triplex connecting link

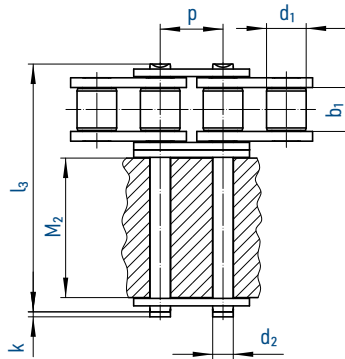

Simplex chain
with duplex connecting link

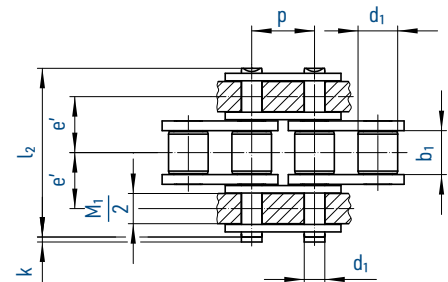

Duplex chain
with triplex connecting link

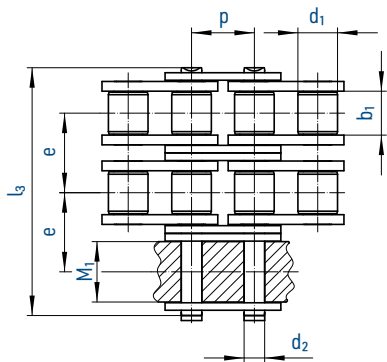

Duplex chain
with triplex connecting link

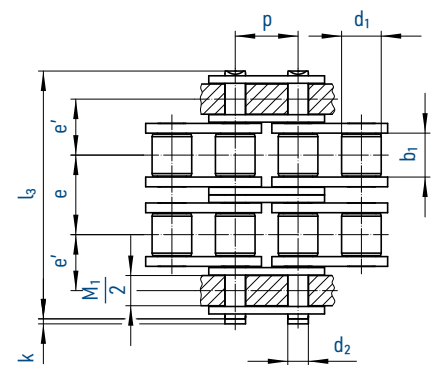

Chain		Pitch		Inner width b_1 min.	Roller \varnothing d_1 max.	Pin \varnothing d_2 max.	Transverse pitch		Attachment width		Projection over connecting link k max.	Pin length	
		p					e	e'	M_1 max.	M_2 max.		l_2 max.	l_3 max.
No.	Ind.	mm	inch	mm	mm	mm	mm	mm	mm	mm	mm	mm	
455	¹⁰	9,525	3/8	5,72	6,35	3,28	10,24	7,24	8,5	-	3,3	23,8	-
D 455	¹⁰	9,525	3/8	5,72	6,35	3,28	10,24	7,24	8,5	-	3,3	-	34,0
462	¹⁰	12,700	1/2	7,75	8,51	4,45	13,92	10,10	11,3	25,6	3,9	31,0	-
D 462	¹⁰	12,700	1/2	7,75	8,51	4,45	13,92	10,10	11,3	-	3,9	-	44,9
501	¹⁰	15,875	5/8	9,65	10,16	5,08	16,59	11,62	13,3	30,0	4,1	36,2	-
D 501	¹⁰	15,875	5/8	9,65	10,16	5,08	16,59	11,62	13,3	-	4,1	-	52,8
513	¹⁰	19,050	3/4	11,68	12,07	5,72	19,46	13,63	15,6	34,8	4,6	42,2	-
D 513	¹⁰	19,050	3/4	11,68	12,07	5,72	19,46	13,63	15,6	-	4,6	-	61,7
548	¹⁰	25,400	1	17,02	15,88	8,28	31,88	22,30	25,4	56,8	5,4	68,0	-
D 548	¹⁰	25,400	1	17,02	15,88	8,28	31,88	22,30	25,4	-	5,4	-	99,9

¹⁰ can also be supplied in stainless steel

All designs can also be supplied as MARATHON roller chains (maintenance-free), BIATHLON, BIATHLON KS, TRIATHLON and TRIATHLON KS!
For details on orders and enquiries see page 149. For untoleranced dimensions DIN ISO 2768 c applies.