

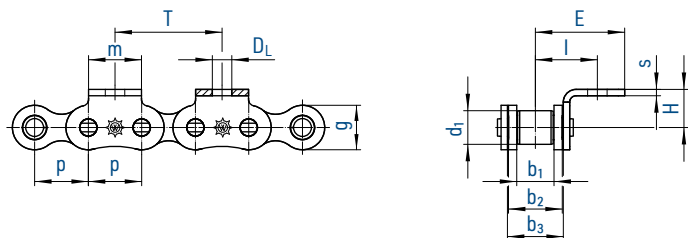

Type A bent attachments, one side

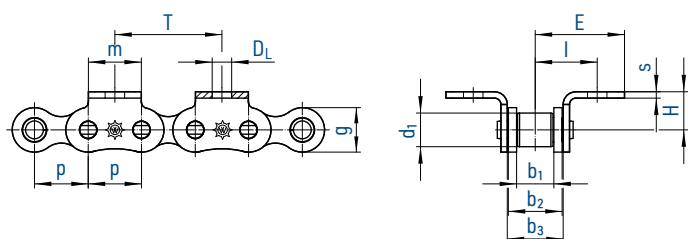

Type B bent attachments, both sides



Type C bent over chain attachments, one side

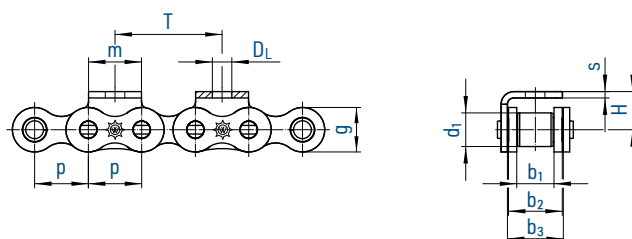

| Basic chain | | Pitch | | Inner width | Inner link width | Outer plate width | Roller Ø | Plate height | Attachment dimensions | | | | | |
|-------------|------------------|--------|-------|---------------------|---------------------|---------------------|---------------------|--------------|-----------------------|----------------|------|------|------|------|
| No. | Ind. | p | | b ₁ min. | b ₂ max. | b ₃ min. | d ₁ max. | g max. | m | D _L | I | F | H | s |
| | | mm | inch | mm | mm | mm | mm | mm | mm | mm | mm | mm | mm | mm |
| 450 | | 8,000 | - | 3,00 | 4,77 | 4,90 | 5,00 | 7,1 | 8,0 | 3,2 | 6,6 | 12,0 | 5,0 | 0,80 |
| 455 | ^{1,15} | 9,525 | 3/8 | 5,72 | 8,53 | 8,66 | 6,35 | 8,2 | 8,0 | 3,5 | 9,5 | 13,5 | 6,5 | 1,25 |
| 331 | ¹⁷ | 12,700 | 1/2 | 3,30 | 5,80 | 5,93 | 7,75 | 9,9 | 10,5 | 3,5 | 9,0 | 15,1 | 7,0 | 0,95 |
| 332 | ¹⁷ | 12,700 | 1/2 | 4,88 | 7,20 | 7,33 | 7,75 | 9,9 | 10,5 | 3,5 | 9,7 | 15,8 | 7,0 | 0,95 |
| 462 | ¹⁵ | 12,700 | 1/2 | 7,75 | 11,30 | 11,43 | 8,51 | 11,8 | 12,5 | 4,5 | 13,1 | 19,0 | 10,0 | 1,50 |
| 501 | ¹⁵ | 15,875 | 5/8 | 9,65 | 13,28 | 13,41 | 10,16 | 14,7 | 15,0 | 5,5 | 16,7 | 26,5 | 10,0 | 1,70 |
| 513 | ¹⁵ | 19,050 | 3/4 | 11,68 | 15,62 | 15,75 | 12,07 | 16,1 | 18,5 | 6,6 | 18,6 | 29,0 | 11,0 | 1,80 |
| 548 | ^{15,16} | 25,400 | 1 | 17,02 | 25,40 | 25,60 | 15,88 | 21,0 | 25,0 | 9,0 | 28,9 | 41,8 | 18,0 | 3,00 |
| 563 | | 31,750 | 1 1/4 | 19,56 | 29,00 | 29,20 | 19,05 | 26,4 | 35,0 | 9,0 | 33,4 | 49,0 | 18,0 | 3,75 |
| 596 | | 38,100 | 1 1/2 | 25,40 | 37,90 | 38,20 | 25,40 | 33,4 | 38,0 | 11,0 | 43,6 | 62,6 | 25,0 | 5,00 |
| 613 | | 44,450 | 1 3/4 | 30,99 | 46,50 | 46,80 | 27,94 | 37,0 | 45,0 | 14,0 | 54,1 | 78,0 | 32,0 | 6,00 |
| 652 | | 50,800 | 2 | 30,99 | 45,50 | 45,80 | 29,21 | 42,2 | 50,0 | 14,0 | 53,6 | 75,4 | 35,0 | 6,00 |
| 40 | ¹⁵ | 12,700 | 1/2 | 7,85 | 11,17 | 11,23 | 7,92 | 12,0 | 10,5 | 3,5 | 12,7 | 17,9 | 7,9 | 1,50 |
| 50 | ¹⁵ | 15,875 | 5/8 | 9,40 | 13,84 | 13,90 | 10,16 | 15,1 | 12,7 | 5,2 | 15,9 | 23,9 | 10,3 | 2,00 |
| 60 | ¹⁵ | 19,050 | 3/4 | 12,57 | 17,75 | 17,81 | 11,91 | 18,1 | 15,9 | 5,2 | 19,1 | 28,2 | 11,9 | 2,40 |
| 80 | ¹⁵ | 25,400 | 1 | 15,75 | 22,60 | 22,66 | 15,88 | 24,1 | 19,1 | 6,7 | 25,4 | 37,3 | 15,9 | 3,20 |

¹ with straight side plates ¹⁵ also with single hole bent attachments on inner link ¹⁶ on inner link s = 4 ¹⁷ can also be supplied with m = 16

All designs can also be supplied as MARATHON roller chains (maintenance-free), BIATHLON, BIATHLON KS, TRIATHLON and TRIATHLON KS! For details on orders and enquiries see page 149. For untoleranced dimensions DIN ISO 2768 c applies.



Type D straight attachments, one side

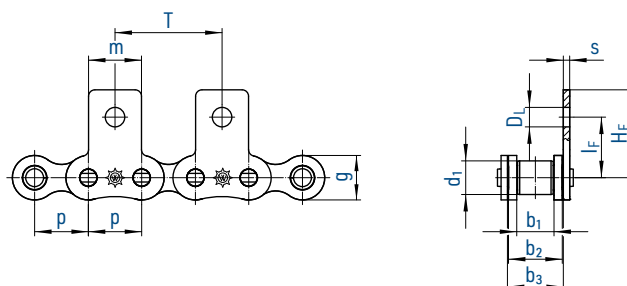

Type E straight attachments, both sides

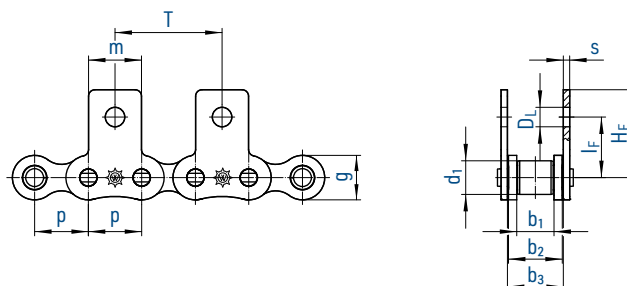

Type F extended pins (available on alternate sides)

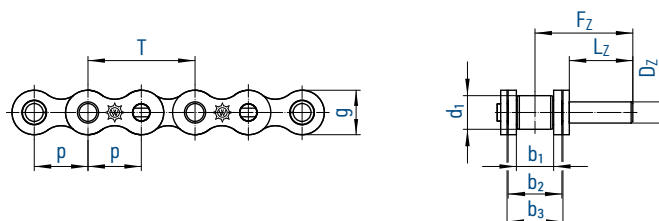

| Basic chain | | Pitch | | Inner width | Inner link width | Outer plate width | Roller Ø | Plate height | Attachment dimensions | | | | | | | |
|-------------|------------------|--------|-------|---------------------|---------------------|---------------------|---------------------|--------------|-----------------------|----------------|----------------|----------------|------|---------------------------------|------------------------------|------------------------------|
| ⚙ | | p | | b ₁ min. | b ₂ max. | b ₃ min. | d ₁ max. | g max. | m | D _L | I _F | H _F | s | D _Z ¹⁹ h9 | L _Z ¹⁹ | F _Z ¹⁹ |
| No. | Ind. | mm | inch | mm | mm | mm | mm | mm | mm | mm | mm | mm | mm | mm | mm | mm |
| 450 | | 8,000 | - | 3,00 | 4,77 | 4,90 | 5,00 | 7,1 | 8,0 | 3,2 | 7,5 | 13,00 | 0,80 | 4,0 | 10,0 | 13,3 |
| 455 | ^{1,18} | 9,525 | 3/8 | 5,72 | 8,53 | 8,66 | 6,35 | 8,2 | 8,0 | 3,5 | 9,3 | 13,30 | 1,25 | 5,0 | 15,0 | 20,7 |
| 331 | ¹⁷ | 12,700 | 1/2 | 3,30 | 5,80 | 5,93 | 7,75 | 9,9 | 10,5 | 3,5 | 11,3 | 17,55 | 0,95 | 5,0 | 15,0 | 19,0 |
| 332 | ¹⁷ | 12,700 | 1/2 | 4,88 | 7,20 | 7,33 | 7,75 | 9,9 | 10,5 | 3,5 | 11,3 | 17,55 | 0,95 | 5,0 | 15,0 | 19,7 |
| 462 | ¹⁸ | 12,700 | 1/2 | 7,75 | 11,30 | 11,43 | 8,51 | 11,8 | 12,5 | 4,5 | 14,7 | 20,30 | 1,50 | 6,0 | 15,0 | 22,4 |
| 501 | ¹⁸ | 15,875 | 5/8 | 9,65 | 13,28 | 13,41 | 10,16 | 14,7 | 15,0 | 5,5 | 17,2 | 26,70 | 1,70 | 6,5 | 20,0 | 28,5 |
| 513 | ¹⁸ | 19,050 | 3/4 | 11,68 | 15,62 | 15,75 | 12,07 | 16,1 | 18,5 | 6,6 | 18,3 | 28,60 | 1,80 | 7,0 | 20,0 | 29,8 |
| 548 | ^{16,18} | 25,400 | 1 | 17,02 | 25,40 | 25,60 | 15,88 | 21,0 | 25,0 | 9,0 | 28,6 | 41,50 | 3,00 | 10,0 | 30,0 | 45,9 |
| 563 | | 31,750 | 1 1/4 | 19,56 | 29,00 | 29,20 | 19,05 | 26,4 | 35,0 | 9,0 | 30,5 | 46,00 | 3,75 | 12,0 | 30,0 | 48,4 |
| 596 | | 38,100 | 1 1/2 | 25,40 | 37,90 | 38,20 | 25,40 | 33,4 | 38,0 | 11,0 | 41,0 | 60,00 | 5,00 | 16,0 | 35,0 | 59,1 |
| 613 | | 44,450 | 1 3/4 | 30,99 | 46,50 | 46,80 | 27,94 | 37,0 | 45,0 | 14,0 | 52,5 | 75,50 | 6,00 | 20,0 | 40,0 | 69,0 |
| 652 | | 50,800 | 2 | 30,99 | 45,50 | 45,80 | 29,21 | 42,2 | 50,0 | 14,0 | 53,5 | 76,10 | 6,00 | 20,0 | 40,0 | 69,0 |
| 40 | | 12,700 | 1/2 | 7,85 | 11,17 | 11,23 | 7,92 | 12,0 | 10,5 | 3,5 | 11,5 | 17,65 | 1,50 | 5,0 | 15,0 | 22,2 |
| 50 | | 15,875 | 5/8 | 9,40 | 13,84 | 13,90 | 10,16 | 15,1 | 12,7 | 5,2 | 15,9 | 23,50 | 2,00 | 5,08 | 11,9 | 21,1 |
| 60 | | 19,050 | 3/4 | 12,57 | 17,75 | 17,81 | 11,91 | 18,1 | 15,9 | 5,2 | 18,3 | 27,20 | 2,40 | 5,94 | 14,3 | 25,8 |
| 80 | | 25,400 | 1 | 15,75 | 22,60 | 22,66 | 15,88 | 24,1 | 19,1 | 6,7 | 24,6 | 35,50 | 3,20 | 7,92 | 19,1 | 33,7 |

¹ with straight side plates ¹⁶ on inner link s = 4 ¹⁷ can also be supplied with m = 16 ¹⁸ also with straight attachments on inner link

¹⁹ other dimensions available on request

All designs can also be supplied as MARATHON roller chains (maintenance-free), BIATHLON, BIATHLON KS, TRIATHLON and TRIATHLON KS!
For details on orders and enquiries see page 149. For untoleranced dimensions DIN ISO 2768 c applies.



Type A2 bent attachments, one side

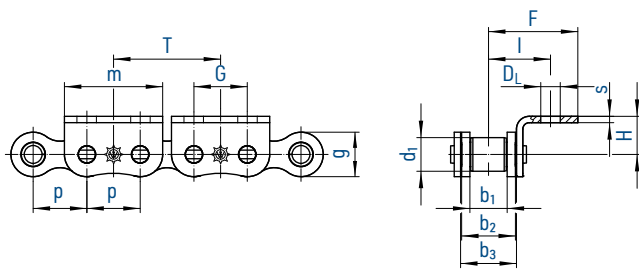

Type B2 bent attachments, both sides

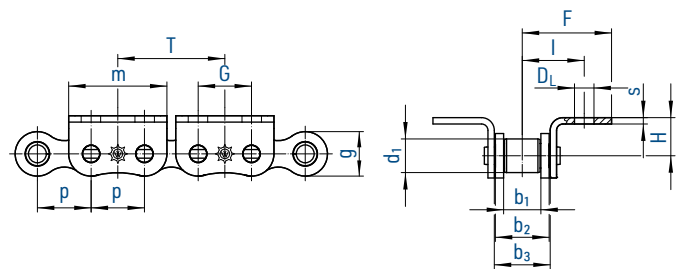

Type D2 straight attachments, one side

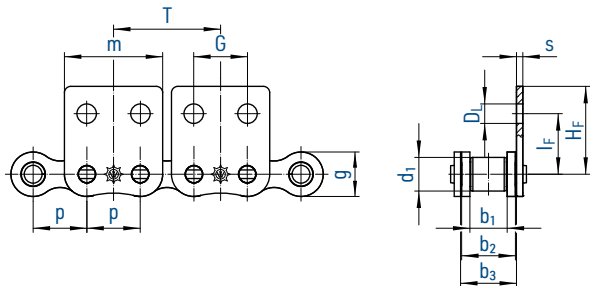

Type E2 straight attachments, both sides

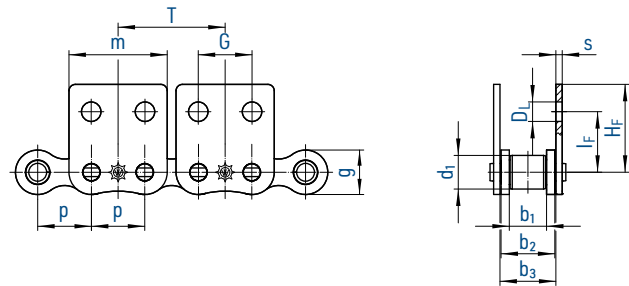

| Basic chain | | Pitch | | Inner width | Inner link width | Outer plate width | Roller Ø | Plate height | Attachment dimensions | | | | | | | | |
|-------------|-----------------|--------|-------|---------------------|---------------------|---------------------|---------------------|--------------|-----------------------|----------------|------|------|------|------|----------------|----------------|------|
| ⚙ | | p | | b ₁ min. | b ₂ max. | b ₃ min. | d ₁ max. | g max. | m | D _L | G | I | F | H | l _F | H _F | s |
| No. | Ind. | mm | inch | mm | mm | mm | mm | mm | mm | mm | mm | mm | mm | mm | mm | mm | mm |
| 455 | ^{1,20} | 9,525 | 3/8 | 5,72 | 8,53 | 8,66 | 6,35 | 8,2 | 18,2 | 3,2 | 9,5 | 9,8 | 13,5 | 5,7 | 9,2 | 12,6 | 1,25 |
| 462 | | 12,700 | 1/2 | 7,75 | 11,30 | 11,43 | 8,51 | 11,8 | 24,4 | 4,5 | 12,7 | 13,1 | 19,0 | 10,0 | 14,7 | 20,3 | 1,50 |
| 501 | | 15,875 | 5/8 | 9,65 | 13,28 | 13,41 | 10,16 | 14,7 | 30,3 | 5,5 | 15,9 | 16,7 | 26,5 | 10,0 | 17,2 | 26,7 | 1,70 |
| 513 | | 19,050 | 3/4 | 11,68 | 15,62 | 15,75 | 12,07 | 16,1 | 34,8 | 6,6 | 19,1 | 18,6 | 29,0 | 11,0 | 18,7 | 28,6 | 1,80 |
| 548 | | 25,400 | 1 | 17,02 | 25,40 | 25,60 | 15,88 | 21,0 | 46,5 | 9,0 | 25,4 | 28,9 | 41,8 | 18,0 | 28,6 | 41,5 | 3,00 |
| 563 | | 31,750 | 1 1/4 | 19,56 | 29,00 | 29,20 | 19,05 | 26,4 | 55,8 | 9,0 | 31,8 | 33,4 | 49,4 | 18,0 | 30,5 | 46,0 | 3,75 |
| 596 | | 38,100 | 1 1/2 | 25,40 | 37,90 | 38,10 | 25,40 | 33,4 | 71,1 | 11,0 | 38,1 | 43,6 | 62,6 | 25,0 | 41,0 | 60,0 | 5,00 |

Roller chains (stainless steel) with two-hole bent and straight attachments

| | | | | | | | | | | | | | | | | | |
|--------|-----------------|--------|-----|-------|-------|-------|-------|------|------|------|------|------|------|------|------|------|------|
| 455 RF | ^{1,20} | 9,525 | 3/8 | 5,72 | 8,53 | 8,66 | 6,35 | 8,2 | 18,2 | 3,2 | 9,5 | 9,8 | 13,2 | 5,7 | 9,2 | 12,6 | 1,25 |
| 462 RF | | 12,700 | 1/2 | 7,75 | 11,30 | 11,43 | 8,51 | 11,8 | 24,4 | 4,5 | 12,7 | 13,1 | 19,0 | 10,0 | 14,7 | 20,3 | 1,60 |
| 501 RF | | 15,875 | 5/8 | 9,65 | 13,28 | 13,41 | 10,16 | 14,7 | 30,3 | 5,5 | 15,9 | 16,7 | 26,5 | 10,0 | 17,2 | 26,7 | 1,70 |
| 513 RF | | 19,050 | 3/4 | 11,68 | 15,62 | 15,75 | 12,07 | 16,1 | 34,8 | 6,6 | 19,1 | 18,5 | 29,0 | 11,0 | 18,7 | 28,6 | 1,80 |
| 548 RF | | 25,400 | 1 | 17,02 | 25,40 | 25,60 | 15,88 | 21,0 | 46,5 | 10,0 | 25,4 | 28,9 | 41,8 | 18,0 | 28,6 | 41,5 | 3,00 |

¹ with straight side plates ²⁰ can be supplied with or without bore

All designs can also be supplied as MARATHON roller chains (maintenance-free), BIATHLON, BIATHLON KS, TRIATHLON and TRIATHLON KS! Sprockets made of stainless steel or plastic are available on request.

For details on orders and enquiries see page 149. For untoleranced dimensions DIN ISO 2768 c applies.



Type A bent attachments, one side

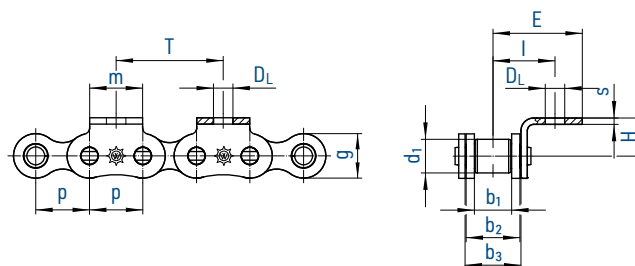

Type B bent attachments, both sides

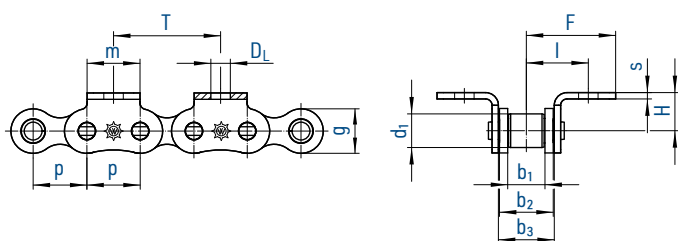

Type D straight attachments, one side

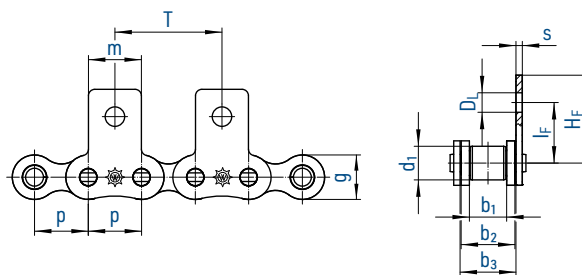

Type E straight attachments, both sides

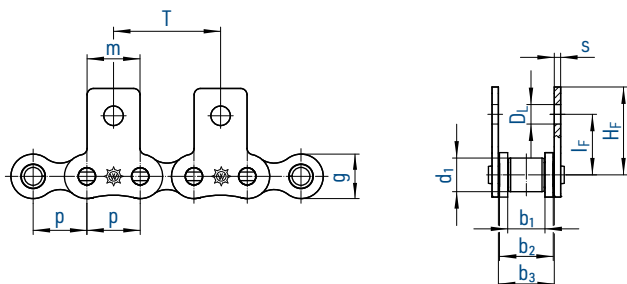

Type F extended pins (available on alternate sides)

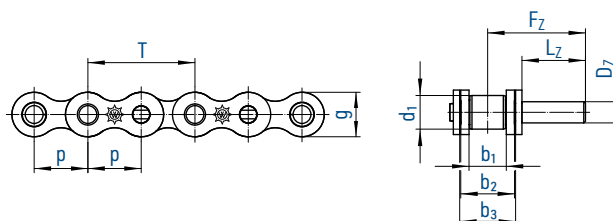

| Basic chain | | Pitch | Inner width | Inner link width | Outer plate width | Roller Ø | Plate height | Attachment dimensions | | | | | | | | | | | |
|-------------|------------------|--------|-------------|------------------|-------------------|----------|--------------|-----------------------|---------------------|---------------------|---------------------|---------------------|--------|------|----------------|------|----|------|----------------|
| | | | | | | | | p | b ₁ min. | b ₂ max. | b ₃ min. | d ₁ max. | g max. | m | D _L | I | F | H | I _F |
| No. | Ind. | mm | mm | mm | mm | mm | mm | mm | mm | mm | mm | mm | mm | mm | mm | mm | mm | mm | mm |
| 450 RF | | 8,000 | 3,00 | 4,77 | 4,90 | 5,00 | 7,1 | 8,0 | 3,2 | 6,6 | 12,0 | 5,0 | 7,5 | 13,0 | 0,80 | 4,0 | 10 | 13,3 | |
| 455 RF | ^{1,21} | 9,525 | 5,72 | 8,53 | 8,66 | 6,35 | 8,2 | 8,0 | 3,5 | 9,5 | 13,5 | 6,5 | 9,3 | 13,3 | 1,25 | 5,0 | 15 | 20,7 | |
| 331 RF | ¹⁷ | 12,700 | 3,30 | 5,80 | 5,93 | 7,75 | 9,9 | 10,5 | 3,5 | 9,0 | 15,1 | 7,0 | 11,3 | 17,6 | 0,95 | 5,0 | 15 | 19,0 | |
| 40 RF | ²¹ | 12,700 | 7,85 | 11,15 | 11,28 | 7,95 | 12,0 | 10,5 | 3,5 | 11,8 | 17,9 | 7,9 | 11,5 | 17,7 | 1,50 | 5,0 | 15 | 22,2 | |
| 332 RF | ¹⁷ | 12,700 | 4,88 | 7,20 | 7,33 | 7,75 | 9,9 | 10,5 | 3,5 | 9,7 | 15,8 | 7,0 | 11,5 | 17,6 | 0,95 | 5,0 | 15 | 19,7 | |
| 462 RF | ²¹ | 12,700 | 7,75 | 11,30 | 11,43 | 8,51 | 11,8 | 12,5 | 4,5 | 13,1 | 19,0 | 10,0 | 14,7 | 20,3 | 1,60 | 6,0 | 15 | 22,4 | |
| 501 RF | ²¹ | 15,875 | 9,65 | 13,28 | 13,41 | 10,16 | 14,7 | 15,0 | 5,5 | 16,7 | 27,0 | 10,0 | 17,2 | 26,7 | 1,70 | 6,5 | 20 | 28,5 | |
| 513 RF | ²¹ | 19,050 | 11,68 | 15,62 | 15,75 | 12,07 | 16,1 | 18,5 | 6,6 | 18,5 | 29,0 | 11,0 | 18,3 | 28,6 | 1,80 | 7,0 | 20 | 29,8 | |
| 548 RF | ^{16,21} | 25,400 | 17,02 | 25,40 | 25,60 | 15,88 | 21,0 | 25,0 | 10,0 | 28,9 | 41,8 | 18,0 | 28,6 | 41,5 | 3,00 | 10,0 | 30 | 45,9 | |

¹ with straight side plates ¹⁶ on inner link s = 4 ¹⁷ can also be supplied with m = 16 ¹⁹ other dimensions available on request
²¹ also with single hole bent attachments on inner link

Sprockets made of stainless steel or plastic are available on request.

For details on orders and enquiries see page 149. For untoleranced dimensions DIN ISO 2768 c applies.



Type A G
bent attachments, one side

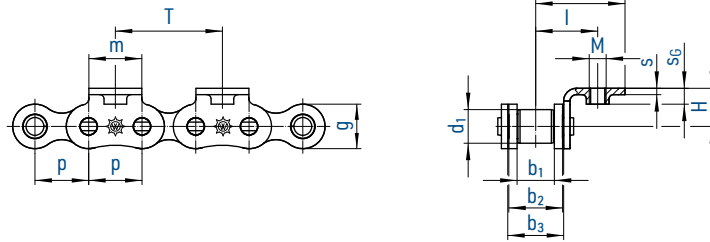

Type B G
bent attachments, both sides

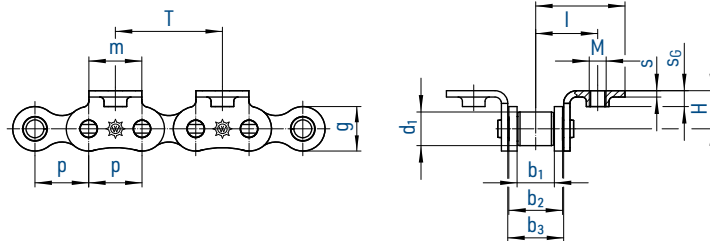

Type C G
bent over chain attachments, one side

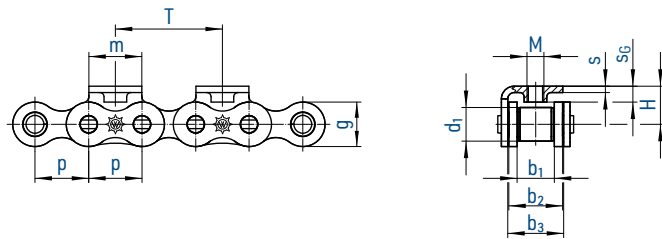

Type D G
straight attachments, one side

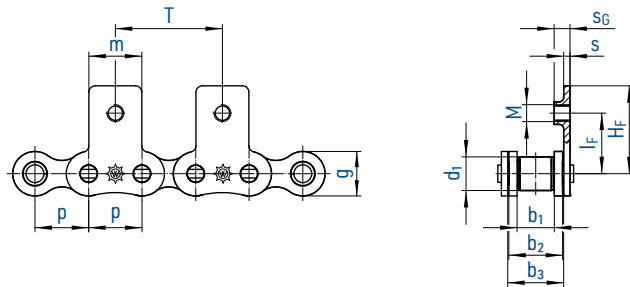

Type E G
straight attachments, both sides

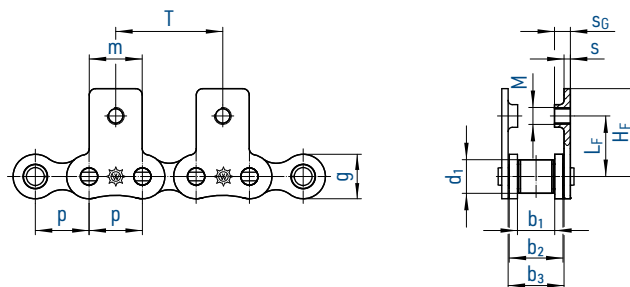

| Basic chain | | Pitch | | Inner width | Inner link width | Outer plate width | Roller Ø | Plate height | Attachment dimensions | | | | | | | | |
|-------------|---------------|--------|------|------------------------|------------------------|------------------------|------------------------|--------------|-----------------------|--------------------|------|------|----|------|------|-----|----------------|
| | | p | | b ₁ min. | b ₂ max. | b ₃ min. | d ₁ max. | g max. | m | M Inside thread | l | F | H | IF | HF | s | s _G |
| No. | Ind. | mm | inch | mm | mm | mm | mm | mm | mm | mm | mm | mm | mm | mm | mm | mm | mm |
| 462 | ²² | 12,700 | 1/2 | 7,75 | 11,30 | 11,43 | 8,51 | 11,8 | 12,5 | M 4 | 13,1 | 19,0 | 10 | 14,7 | 20,3 | 1,5 | 4,0 |
| 501 | ²² | 15,875 | 5/8 | 9,65 | 13,28 | 13,41 | 10,16 | 14,7 | 15,0 | M 5 | 16,7 | 27,0 | 10 | 17,2 | 26,7 | 1,7 | 4,2 |
| 513 | ²² | 19,050 | 3/4 | 11,68 | 15,62 | 15,75 | 12,07 | 16,1 | 18,5 | M 6 | 18,5 | 29,0 | 11 | 18,3 | 28,6 | 1,8 | 4,5 |
| 548 | ²² | 25,400 | 1 | 17,02 | 25,40 | 25,60 | 15,88 | 21,0 | 25,0 | M 8 | 28,9 | 41,8 | 18 | 28,6 | 41,5 | 3,0 | 7,5 |

²² can also be supplied in stainless steel

All designs can also be supplied as MARATHON roller chains (maintenance-free), BIATHLON, BIATHLON KS, TRIATHLON and TRIATHLON KS!
For details on orders and enquiries see page 149. For untoleranced dimensions DIN ISO 2768 c applies.

Type A 2 G

bent attachments, one side

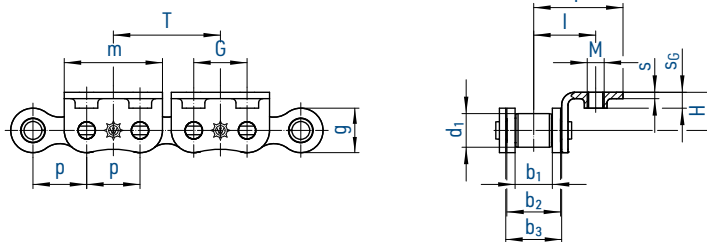

Type B 2 G

bent attachments, both sides

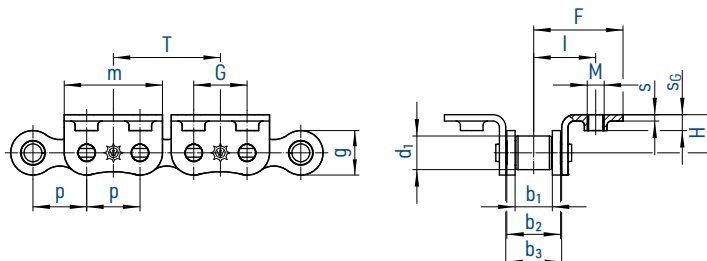

Type C 2 G

bent over chain attachments, one side

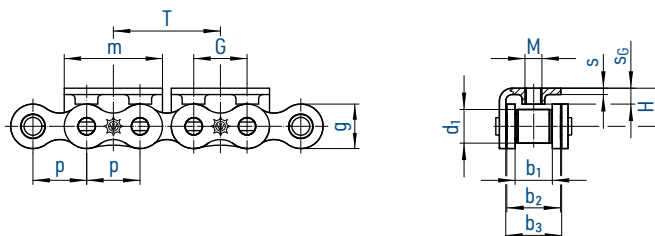

Type D 2 G

straight attachments, one side

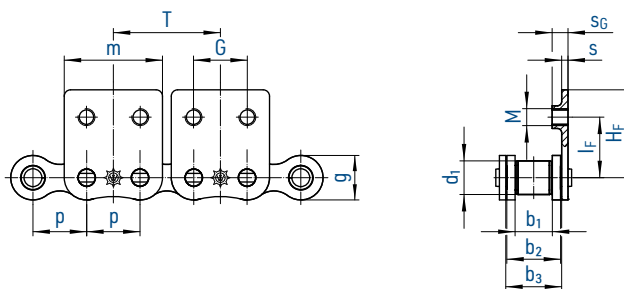

Type E 2 G

straight attachments, both sides

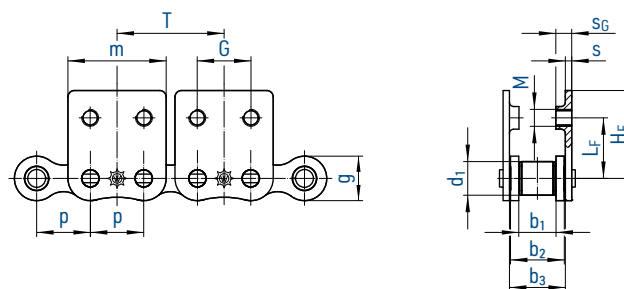

| Basic chain | | Pitch | Inner width | Inner link width | Outer plate width | Roller Ø | Plate height | Attachment dimensions | | | | | | | | | |
|-------------|---------------|--------|---------------------|---------------------|---------------------|---------------------|--------------|-----------------------|-------------------|------|------|------|----|----------------|----------------|-----|----------------|
| No. | Ind. | p | b ₁ min. | b ₂ max. | b ₃ min. | d ₁ max. | g max. | m | M (Inside thread) | G | I | F | H | l _F | H _F | s | s _G |
| | | mm | mm | mm | mm | mm | mm | mm | mm | mm | mm | mm | mm | mm | mm | mm | mm |
| 462 | ²² | 12,700 | 7,75 | 11,30 | 11,43 | 8,51 | 11,8 | 24,4 | M 4 | 12,7 | 13,1 | 19,0 | 10 | 14,7 | 20,3 | 1,5 | 4,0 |
| 501 | ²² | 15,875 | 9,65 | 13,28 | 13,41 | 10,16 | 14,7 | 30,3 | M 5 | 15,9 | 16,7 | 27,0 | 10 | 17,2 | 26,7 | 1,7 | 4,2 |
| 513 | ²² | 19,050 | 11,68 | 15,62 | 15,75 | 12,07 | 16,1 | 34,8 | M 6 | 19,1 | 18,5 | 29,0 | 11 | 18,3 | 28,6 | 1,8 | 4,5 |
| 548 | ²² | 25,400 | 17,02 | 25,40 | 25,60 | 15,88 | 21,0 | 46,5 | M 8 | 25,4 | 28,9 | 41,8 | 18 | 28,6 | 41,5 | 3,0 | 7,5 |

²² can also be supplied in stainless steel

All designs can also be supplied as MARATHON roller chains (maintenance-free), BIATHLON, BIATHLON KS, TRIATHLON and TRIATHLON KS! For details on orders and enquiries see page 149. For untoleranced dimensions DIN ISO 2768 c applies.



Type A
bent attachments, one side

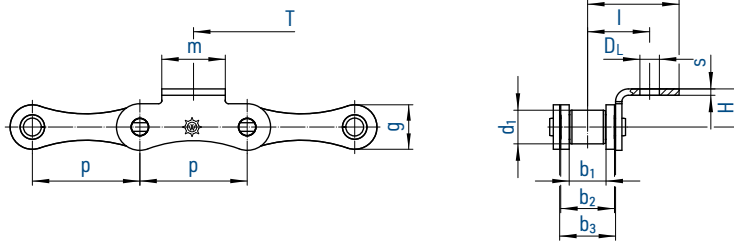

Type B
bent attachments, both sides

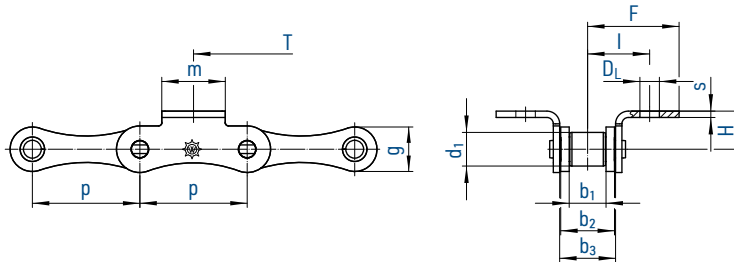

Type C
bent over chain attachments, one side

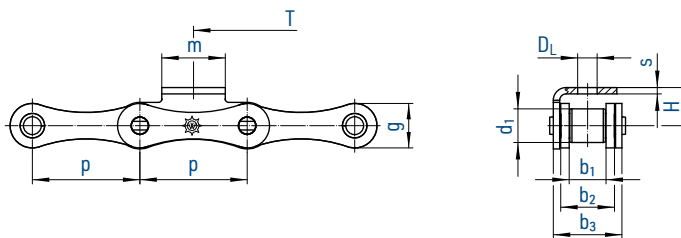

| Basic chain | | Pitch | | Inner width | Inner link width | Outer plate width | Roller Ø | Plate height | Attachment dimensions | | | | | |
|-------------|------|-------|------|---------------------|---------------------|---------------------|---------------------|--------------|-----------------------|----------------|------|------|------|------|
| ⚙️ | | p | | b ₁ min. | b ₂ max. | b ₃ min. | d ₁ max. | g max. | m | D _L | l | F | H | s |
| No. | Ind. | mm | inch | mm | mm | mm | mm | mm | mm | mm | mm | mm | mm | mm |
| 713 | | 25,40 | 1 | 7,75 | 11,30 | 11,43 | 8,51 | 11,8 | 13,0 | 4,5 | 13,1 | 19,3 | 10,0 | 1,60 |
| 717 | | 31,75 | 1 ¼ | 9,65 | 13,28 | 13,41 | 10,16 | 14,7 | 15,0 | 5,5 | 16,7 | 26,7 | 10,0 | 1,70 |
| 722 | | 38,10 | 1 ½ | 11,68 | 15,62 | 15,75 | 12,07 | 16,1 | 19,0 | 6,6 | 18,5 | 26,0 | 11,0 | 1,80 |
| 728 | | 50,80 | 2 | 17,02 | 25,45 | 25,58 | 15,88 | 21,0 | 30,0 | 9,0 | 28,9 | 43,0 | 18,0 | 3,00 |
| 734 | * | 63,50 | 2 ½ | 19,56 | 29,01 | 29,14 | 19,05 | 28,5 | 35,0 | 9,0 | 33,1 | 49,6 | 18,0 | 3,75 |

* g-measurement not according to standard

Double pitch stainless steel roller chains with single hole bent attachments

| | | | | | | | | | | | | | | |
|---------------|--|-------|-----|-------|-------|-------|-------|------|------|-----|------|------|------|------|
| 713 RF | | 25,40 | 1 | 7,75 | 11,30 | 11,43 | 8,51 | 11,8 | 13,0 | 4,5 | 13,1 | 19,5 | 10,0 | 1,60 |
| 717 RF | | 31,75 | 1 ¼ | 9,65 | 13,28 | 13,41 | 10,16 | 14,7 | 15,0 | 5,5 | 16,7 | 26,7 | 10,0 | 1,70 |
| 722 RF | | 38,10 | 1 ½ | 11,68 | 15,62 | 15,75 | 12,07 | 16,1 | 19,0 | 6,6 | 18,5 | 26,0 | 11,0 | 1,80 |
| 728 RF | | 50,80 | 2 | 17,02 | 25,45 | 25,58 | 15,88 | 21,0 | 30,0 | 9,0 | 28,9 | 43,0 | 18,0 | 3,00 |

All designs can also be supplied as MARATHON roller chains (maintenance-free)!
For details on orders and enquiries see page 149. For untoleranced dimensions DIN ISO 2768 c applies.

Type D
straight attachments, one side

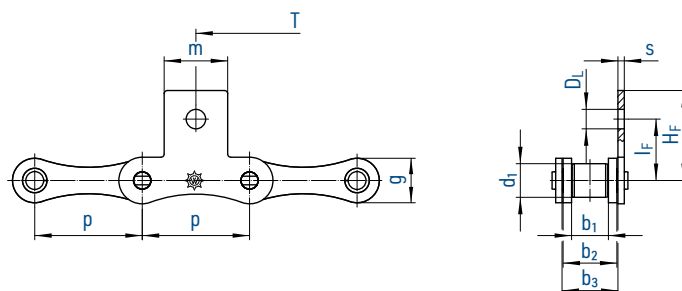

Type E
straight attachments, both sides

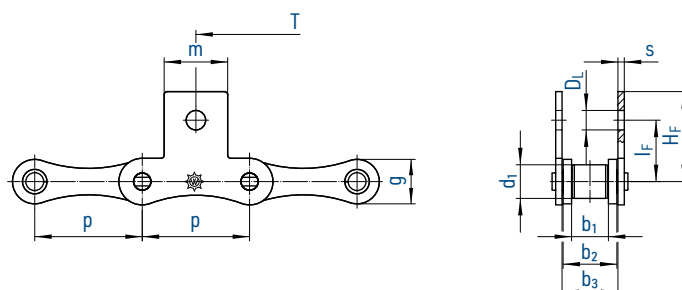

Type F
extended pin
(available on alternate sides)

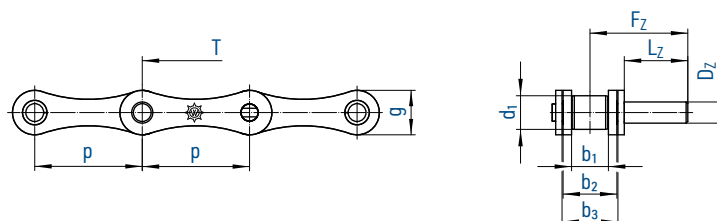

| Basic chain | | Pitch | | Inner width | Inner link width | | Outer plate width | Roller Ø | Plate height | Attachment dimensions | | | | | | |
|-------------|------|-------|------|-------------|------------------|-------|-------------------|----------|--------------|-----------------------|---------------------|---------------------|---------------------|---------------------|--------|------|
| | | | | | | | | | | p | b ₁ min. | b ₂ max. | b ₃ min. | d ₁ max. | g max. | m |
| No. | Ind. | mm | inch | mm | mm | mm | mm | mm | mm | mm | mm | mm | mm | mm | mm | mm |
| 713 | | 25,40 | 1 | 7,75 | 11,30 | 11,43 | 8,51 | 11,8 | 13,0 | 4,5 | 14,7 | 20,3 | 1,60 | 6,0 | 15,0 | 22,4 |
| 717 | | 31,75 | 1 ¼ | 9,65 | 13,28 | 13,41 | 10,16 | 14,7 | 15,0 | 5,5 | 17,0 | 26,7 | 1,70 | 6,5 | 20,0 | 28,5 |
| 722 | | 38,10 | 1 ½ | 11,68 | 15,62 | 15,75 | 12,07 | 16,1 | 19,0 | 6,6 | 17,6 | 26,0 | 1,80 | 7,0 | 20,0 | 29,8 |
| 728 | | 50,80 | 2 | 17,02 | 25,45 | 25,58 | 15,88 | 21,0 | 30,0 | 9,0 | 29,0 | 42,5 | 3,00 | 10,0 | 30,0 | 45,9 |
| 734 | * | 63,50 | 2 ½ | 19,56 | 29,01 | 29,14 | 19,05 | 28,5 | 35,0 | 9,0 | 30,5 | 45,7 | 3,75 | 12,0 | 30,0 | 48,4 |

* g-measurement not according to standard

Double pitch roller chains (stainless steel) with single hole straight attachments and extended pins

| | | | | | | | | | | | | | | | | |
|---------------|--|-------|-----|-------|-------|-------|-------|------|------|-----|------|------|------|------|------|------|
| 713 RF | | 25,40 | 1 | 7,75 | 11,30 | 11,43 | 8,51 | 11,8 | 13,0 | 4,5 | 14,7 | 20,3 | 1,60 | 6,0 | 15,0 | 22,4 |
| 717 RF | | 31,75 | 1 ¼ | 9,65 | 13,28 | 13,41 | 10,16 | 14,7 | 15,0 | 5,5 | 17,0 | 26,7 | 1,70 | 6,5 | 20,0 | 28,5 |
| 722 RF | | 38,10 | 1 ½ | 11,68 | 15,62 | 15,75 | 12,07 | 16,1 | 19,0 | 6,6 | 17,6 | 26,0 | 1,80 | 7,0 | 20,0 | 29,8 |
| 728 RF | | 50,80 | 2 | 17,02 | 25,45 | 25,58 | 15,88 | 21,0 | 30,0 | 9,0 | 29,0 | 42,5 | 3,00 | 10,0 | 30,0 | 45,9 |

¹⁹ can also be supplied in stainless steel

Can also be supplied as MARATHON roller chain (maintenance-free)!

For details on orders and enquiries see page 149. For untoleranced dimensions DIN ISO 2768 c applies.

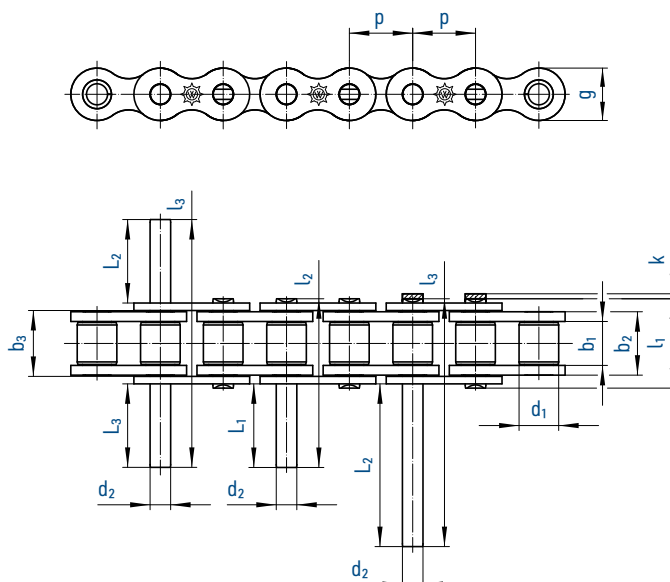

| Basic chain | | Pitch | | Inner width | Inner link width | Outer plate width | Roller Ø | Pin Ø | Projection over connecting link | Plate height | Width over pin | Dimensions for extended pin | | | | |
|-------------|-----------------|--------|-------|---------------------|---------------------|---------------------|---------------------|---------------------|---------------------------------|--------------|---------------------|-----------------------------------|-----------------------------------|---------------------|---------------------|---------------------|
| | | p | | b ₁ min. | b ₂ max. | b ₃ min. | d ₁ max. | d ₂ max. | k max. | g max. | l ₁ max. | Overall length | | Pin extension | | |
| No. | Ind. | mm | inch | mm | mm | mm | mm | mm | mm | mm | mm | l ₂ ¹¹ max. | l ₃ ¹² max. | L ₁ max. | L ₂ max. | L ₃ max. |
| 450 | | 8,000 | - | 3,00 | 4,77 | 4,90 | 5,00 | 2,31 | 3,1 | 7,1 | 8,6 | 14,3 | 19,9 | 6,3 | 12,2 | 6,35 |
| 455 | ^{1,10} | 9,525 | 3/8 | 5,72 | 8,53 | 8,66 | 6,35 | 3,28 | 3,3 | 8,2 | 13,5 | 23,1 | 33,7 | 11,0 | 21,6 | 11,15 |
| 462 | ¹⁰ | 12,700 | 1/2 | 7,75 | 11,30 | 11,43 | 8,51 | 4,45 | 3,9 | 11,8 | 17,0 | 30,7 | 44,9 | 15,3 | 29,5 | 15,30 |
| 501 | ¹⁰ | 15,875 | 5/8 | 9,65 | 13,28 | 13,41 | 10,16 | 5,08 | 4,1 | 14,7 | 19,6 | 36,2 | 52,8 | 18,2 | 34,8 | 18,00 |
| 513 | ¹⁰ | 19,050 | 3/4 | 11,68 | 15,62 | 15,75 | 12,07 | 5,72 | 4,6 | 16,1 | 22,7 | 41,8 | 61,3 | 21,0 | 40,5 | 20,90 |
| 548 | ¹⁰ | 25,400 | 1 | 17,02 | 25,40 | 25,60 | 15,88 | 8,28 | 5,4 | 21,0 | 36,0 | 67,5 | 99,3 | 33,6 | 65,4 | 33,70 |
| 552 | ¹⁰ | 30,000 | - | 17,02 | 25,40 | 25,60 | 15,88 | 8,28 | 5,4 | 21,0 | 36,0 | 67,5 | 99,3 | 33,6 | 65,4 | 33,70 |
| 563 | | 31,750 | 1 1/4 | 19,56 | 29,00 | 29,20 | 19,05 | 10,19 | 6,1 | 26,4 | 41,5 | 79,7 | 116,1 | 38,6 | 75,3 | 38,70 |
| 577 | | 35,000 | - | 19,60 | 27,00 | 27,20 | 19,05 | 10,19 | 6,1 | 26,0 | 38,3 | 79,7 | 116,1 | 41,8 | 78,5 | 41,80 |
| 596 | | 38,100 | 1 1/2 | 25,40 | 37,90 | 38,10 | 25,40 | 14,63 | 6,6 | 33,4 | 53,0 | 101,8 | 150,2 | 50,5 | 98,7 | 50,50 |
| 613 | | 44,450 | 1 3/4 | 30,99 | 46,60 | 46,70 | 27,94 | 15,90 | 7,4 | 37,0 | 63,6 | 124,7 | 184,3 | 61,7 | 121,7 | 62,00 |
| 652 | | 50,800 | 2 | 30,99 | 45,60 | 45,70 | 29,21 | 17,81 | 7,9 | 42,3 | 63,6 | 126,0 | 184,5 | 62,2 | 121,2 | 62,10 |
| 35 | ¹⁰ | 9,525 | 3/8 | 4,68 | 7,47 | 7,52 | 5,08 | 3,59 | 3,3 | 9,1 | 13,2 | 22,0 | 32,5 | 11,0 | 21,5 | 11,10 |
| 40 | ¹⁰ | 12,700 | 1/2 | 7,85 | 11,15 | 11,28 | 7,95 | 3,96 | 3,9 | 12,0 | 17,8 | 30,1 | 45,2 | 14,8 | 29,9 | 15,35 |
| 50 | ¹⁰ | 15,875 | 5/8 | 9,40 | 13,80 | 13,93 | 10,16 | 5,08 | 4,1 | 15,0 | 20,5 | 38,7 | 56,8 | 19,4 | 37,5 | 19,40 |
| 60 | ¹⁰ | 19,050 | 3/4 | 12,57 | 17,70 | 17,85 | 11,91 | 5,94 | 4,6 | 18,0 | 25,4 | 48,3 | 71,1 | 24,2 | 47,0 | 24,20 |
| 80 | | 25,400 | 1 | 15,75 | 22,50 | 22,70 | 15,88 | 7,92 | 5,4 | 24,1 | 33,5 | 62,6 | 92,0 | 31,3 | 60,6 | 31,30 |
| 100 | | 31,750 | 1 1/4 | 18,90 | 27,40 | 27,60 | 19,05 | 9,53 | 6,1 | 30,1 | 40,4 | 76,3 | 112,2 | 38,2 | 74,1 | 38,20 |
| 120 | | 38,100 | 1 1/2 | 25,22 | 35,30 | 35,60 | 22,23 | 11,10 | 6,6 | 36,2 | 50,3 | 96,1 | 141,9 | 48,2 | 94,0 | 48,20 |

¹ with straight side plates ¹⁰ can also be supplied in stainless steel ¹¹ Duplex pin ¹² Triplex pin

All designs can also be supplied as MARATHON roller chains (maintenance-free), BIATHLON, BIATHLON KS, TRIATHLON and TRIATHLON KS!
For details on orders and enquiries see page 149. For untoleranced dimensions DIN ISO 2768 c applies.



Simplex chain
with duplex connecting link

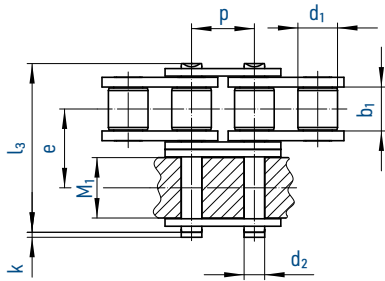

Simplex chain
with triplex connecting link

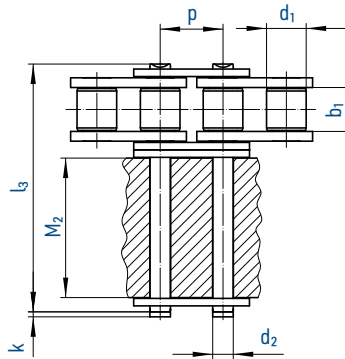

Simplex chain
with duplex connecting link

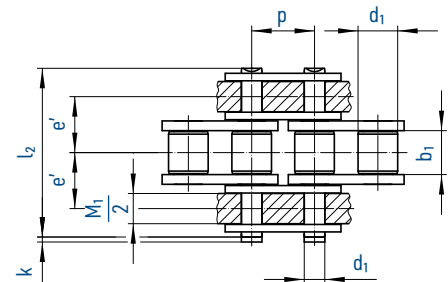

Duplex chain
with triplex connecting link

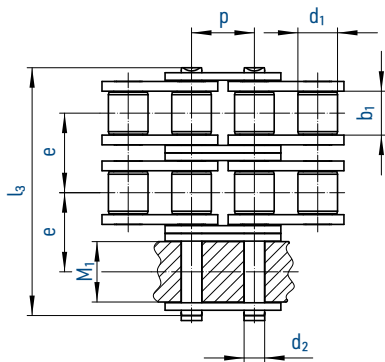

Duplex chain
with triplex connecting link

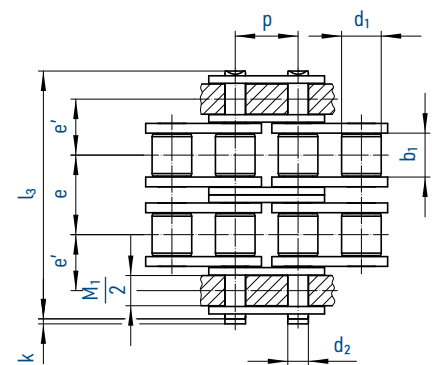

| Chain | | Pitch | | Inner width | Roller Ø | Pin Ø | Transverse pitch | | Attachment width | | Projection over connecting link | Pin length | |
|-------|---------------|--------|------|---------------------|---------------------|---------------------|------------------|-------|---------------------|---------------------|---------------------------------|------------|---------------------|
| No. | Ind. | p | | b ₁ min. | d ₁ max. | d ₂ max. | e | e' | M ₁ max. | M ₂ max. | | k max. | l ₂ max. |
| | | mm | inch | mm | mm | mm | mm | mm | mm | mm | mm | mm | mm |
| 455 | ¹⁰ | 9,525 | 3/8 | 5,72 | 6,35 | 3,28 | 10,24 | 7,24 | 8,5 | - | 3,3 | 23,8 | - |
| D 455 | ¹⁰ | 9,525 | 3/8 | 5,72 | 6,35 | 3,28 | 10,24 | 7,24 | 8,5 | - | 3,3 | - | 34,0 |
| 462 | ¹⁰ | 12,700 | 1/2 | 7,75 | 8,51 | 4,45 | 13,92 | 10,10 | 11,3 | 25,6 | 3,9 | 31,0 | - |
| D 462 | ¹⁰ | 12,700 | 1/2 | 7,75 | 8,51 | 4,45 | 13,92 | 10,10 | 11,3 | - | 3,9 | - | 44,9 |
| 501 | ¹⁰ | 15,875 | 5/8 | 9,65 | 10,16 | 5,08 | 16,59 | 11,62 | 13,3 | 30,0 | 4,1 | 36,2 | - |
| D 501 | ¹⁰ | 15,875 | 5/8 | 9,65 | 10,16 | 5,08 | 16,59 | 11,62 | 13,3 | - | 4,1 | - | 52,8 |
| 513 | ¹⁰ | 19,050 | 3/4 | 11,68 | 12,07 | 5,72 | 19,46 | 13,63 | 15,6 | 34,8 | 4,6 | 42,2 | - |
| D 513 | ¹⁰ | 19,050 | 3/4 | 11,68 | 12,07 | 5,72 | 19,46 | 13,63 | 15,6 | - | 4,6 | - | 61,7 |
| 548 | ¹⁰ | 25,400 | 1 | 17,02 | 15,88 | 8,28 | 31,88 | 22,30 | 25,4 | 56,8 | 5,4 | 68,0 | - |
| D 548 | ¹⁰ | 25,400 | 1 | 17,02 | 15,88 | 8,28 | 31,88 | 22,30 | 25,4 | - | 5,4 | - | 99,9 |

¹⁰ can also be supplied in stainless steel

All designs can also be supplied as MARATHON roller chains (maintenance-free), BIATHLON, BIATHLON KS, TRIATHLON and TRIATHLON KS! For details on orders and enquiries see page 149. For untoleranced dimensions DIN ISO 2768 c applies.